

VRIJE UNIVERSITEIT BRUSSEL

OPEN-MINDED UNIVERSITY AT THE HEART OF EUROPE



“Thinking must never submit itself,
neither to a dogma,
nor to a party,
nor to a passion,
nor to an interest,
nor to a preconceived idea,
nor to anything whatsoever,
except to the facts themselves,
because for it to submit to anything else would be
the end of its existence.”

Henri Poincaré, 1909





TABLE OF CONTENTS

Do you know VUB?	4
Facts & figures	5
More than 180 years of history	6
Brussels, beating heart of Europe	8
Campuses	10
Students & alumni	12
International & exchange students	14
Inclusive university	16
More than education	18
Top Research @VUB	20
UZ Brussel research	22
Network	24
VUB Foundation	25
#WeAreVUB	26

DO YOU KNOW VUB?

VUB, based in the heart of Europe

The Vrije Universiteit Brussel (VUB) is an internationally-oriented university in Brussels, the heart of Europe. Through tailor-made high quality research and education, VUB wants to contribute in an active and committed way to a better society for tomorrow.

That is our mission.

Free inquiry and encouraging critical thinking

VUB is the only Flemish university that has the principles of 'Free Inquiry' written into its articles of association. These principles are based on the writings of French mathematician and natural philosopher Henri Poincaré (1854-1912): *'Thinking must never submit itself'*. It is still our basic philosophy today.



FOUNDATION



€97,650,000
RESEARCH BUDGET

€240,000,000
TURNOVER



31 BACHELORS

1,754 PhDs
IN 3 DOCTORAL
SCHOOLS

74 MASTERS

8 FACULTIES



23 ADVANCED MASTERS



21 POSTGRADUATES



16,508

BRUSSELS HUMANITIES, SCIENCES &
ENGINEERING CAMPUS

INSCRIPTIONS

OF WHICH 24.5% INTERNATIONAL
SPREAD ACROSS 4 CAMPUSES



140

NATIONALITIES



3,391

PERSONNEL

BRUSSELS HEALTH CAMPUS

+ UNIVERSITY HOSPITAL BRUSSELS

BRUSSELS TECHNOLOGY CAMPUS

BRUSSELS PHOTONICS CAMPUS

369,234 CONSULTATIONS

>60,000
ALUMNI



3,691 PERSONNEL



31,501
HOSPITALISATIONS



721
BEDS

UNIVERSITY ASSOCIATION BRUSSELS

20,000
STUDENTS (VUB + Erasmus-
hogeschool Brussel)

MORE THAN 180 YEARS OF HISTORY

How it all started

VUB originated from the French-speaking Université Libre de Bruxelles (ULB), which was founded in 1834 by a Brussels lawyer with Flemish roots, Pierre-Théodore Verhaegen. It was his intention to create a university independent from church and state with academic freedom at its core.

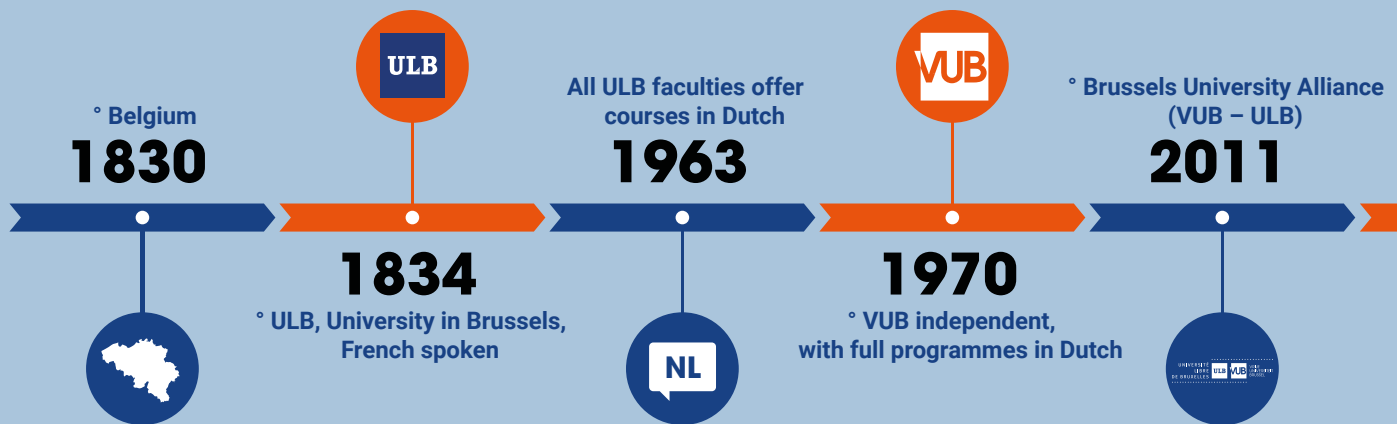

IN 2019-2020 WE CELEBRATE

185 years Together

50 years Single



Science and Brussels

The Solvay Conferences 1911 – 2014

The International Solvay Institutes for Physics and Chemistry, located in Brussels, were founded by the Belgian industrialist Ernest Solvay in 1912, following the historic 1911 Conseil Solvay, considered to be a turning point in the world of Physics. The 1911 conference was attended by among others Albert Einstein, Max Planck, Niels Bohr, Marie Curie, and Henri Poincaré.

Ernest Solvay

(16 April 1838 – 26 May 1922)

Ernest Solvay was a Belgian chemist, industrialist and philanthropist, who after his successful establishment of the company Solvay & Cie, used his considerable wealth to set up the Institute for Sociology at the ULB in 1894, as well as the International Institutes for Physics and Chemistry. In 1903 he set up the Solvay Business School, which today still forms part of the ULB and VUB.

TODAY

1911



2014



The 2014 conference featured among others Nobel prize winner F. Englert

BRUSSELS, BEATING HEART OF EUROPE

- > 1.1 million inhabitants
- 30% of foreign origin
- 108 languages

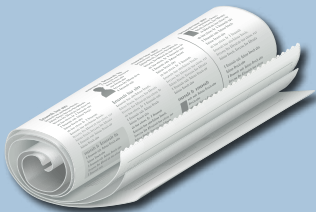

World's largest press centre

- 1,200 accredited journalists
- 979 foreign journalists



- 4th business city in Europe
- > 2,000 international institution headquarters



- International decision centre
- EU & NATO headquarters
- 1st congress city in Europe
- Largest diplomatic community in Europe



FROM BRUSSELS TO

London 2 hours

Paris 1 hour 20 minutes

Frankfurt 3 hours

Amsterdam 2 hours



MAIN CAMPUS ↔ BRUSSELS AIRPORT

25 minutes

2 trains/hour

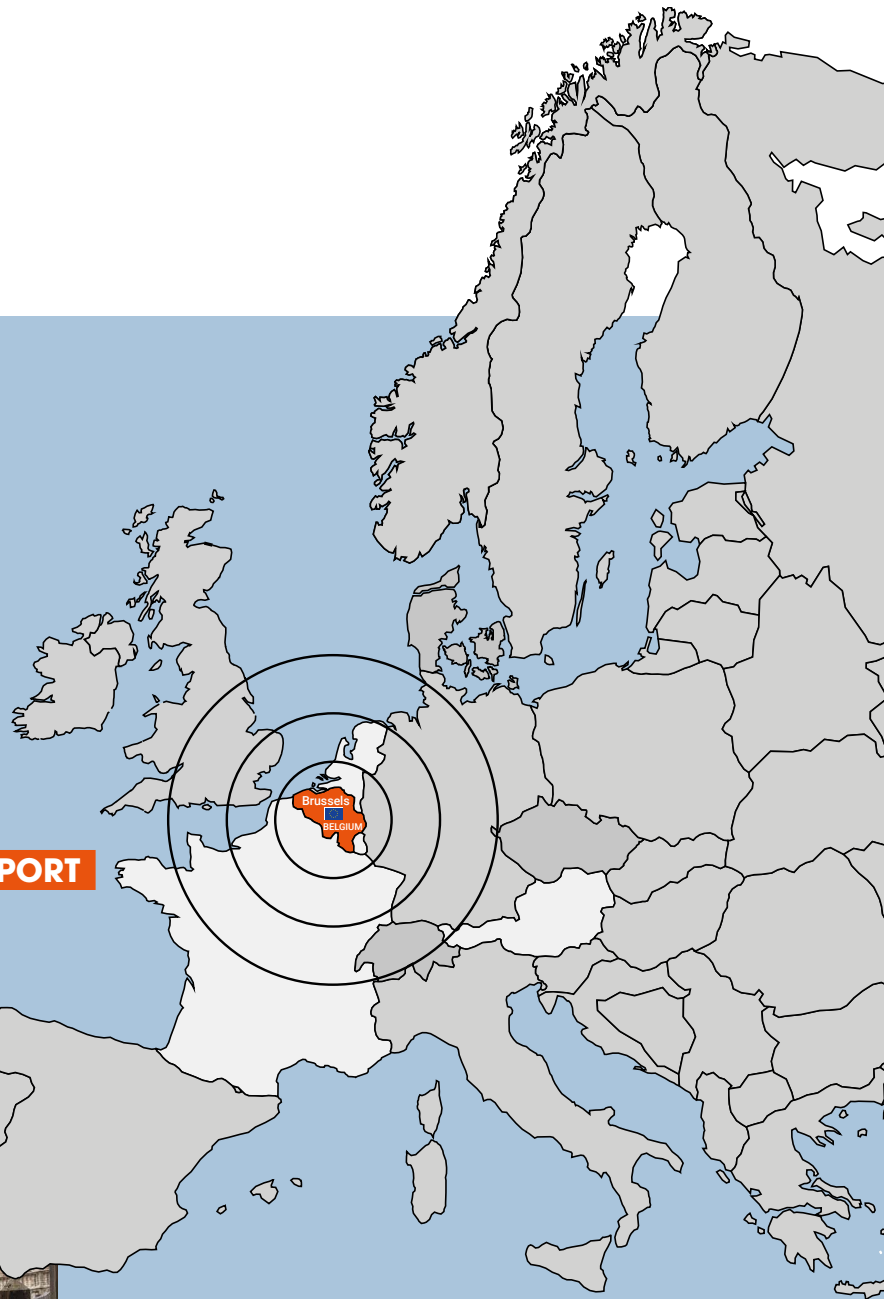

CAMPUSES

375,144 m² surface
Elsene and Jette

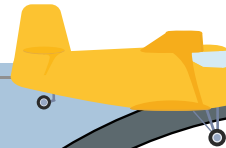

FUTURE INVESTMENTS

- XY building - 6



new auditoria & classrooms

- Usquare (VUB)



research groups

- Learning & Innovation ICT Science & Technology



study & research

- Renovation/consolidation



Brussels Humanities, Sciences & Engineering Campus

Elsene

- 2017: opening Brussels University Consultation Center (BRUCC)
- 2018: opening new swimming pool



Brussels Health Campus

Jette



Brussels Usquare Campus

Elsene

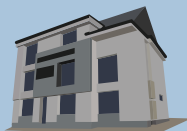

Brussels Photonics Campus

Gooik



Brussels City Campus

Brussel

FUTURE INVESTMENTS IN JETTE

- Theodoortje (nursing facility)
- Research building L (animalarium)





EVENTS IN ELSENE

50 student rooms - Opening 2019



event
hall



art & expo
room



VUB Pilar

3-ULB)



incubators



FABLAB



+/- 600
student rooms

Innovation Center (VUB-ULB) & Technology Park (VUB-ULB)

creation facilities

Conservation Braem building

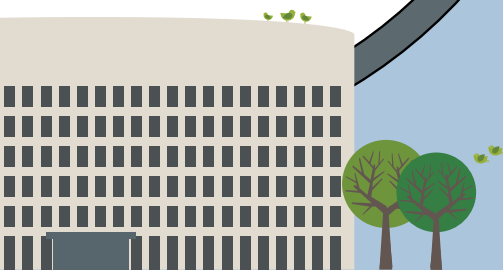

Usquare

VUB and ULB are working with the Brussels Capital Region on the Usquare project. It will mean a new university neighbourhood on the site of the former barracks of the gendarmerie to turn them into a new, lively neighbourhood with room for university services as well as housing for families and students. It will have an interdisciplinary research centre that creates synergies between incubator, StartLab and FabLab. The project is also being given an international dimension, with housing for students and researchers and with international reception spaces.

Learning and Innovation Centre

On the boundary between the VUB and ULB campuses in Brussels, a new building will emerge in a few years' time. The new study centre will offer new learning environments to students from both VUB and ULB: silent rooms for individual study, rooms for course work in groups, experience centres for activities for smaller groups and active learning rooms. Moreover, the ties with external partners from the corporate world will be tightened through project and exposition spaces.



STUDENTS

10.33% FIRST-TIME
UNIVERSITY STUDENTS

1,706

9,687
students

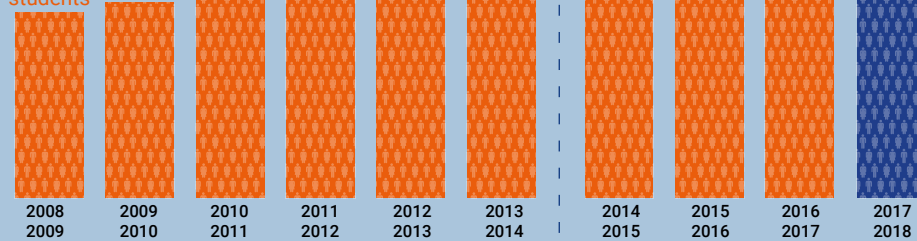

16,508
students *

VUB + EHB:
22,345 STUDENTS

new measuring method
(unique students,
preparation courses included)

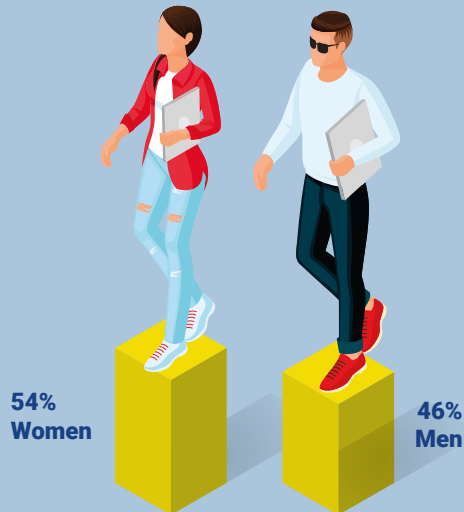

54%
Women

46%
Men

* **156 STUDY PROGRAMMES**

54 ENGLISH-TAUGHT, **102** DUTCH-TAUGHT

ENROLMENTS IN STUDY PROGRAMMES

Bachelors	6,540
Masters	4,946
Advanced Masters	706
PhD	1,811
Postgraduates	151
Teacher Training	102
Preparation courses	1,838
Other (credit students, Erasmus students ...)	1,967

Total of all study programmes is not = # students

ALUMNI

50 GENERATIONS
177 NATIONALITIES

65,000 ambitious professionals

motivated entrepreneurs

critical researchers

engaged citizens

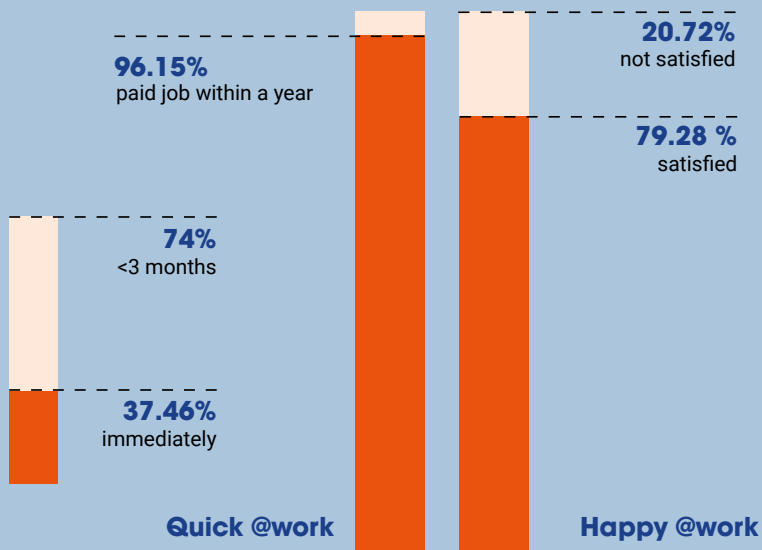

Job security.

About 57.22% has a permanent contract and 29.56% works with a temporary contract. 8.37% is self-employed and only 1.90 is working as an interim.

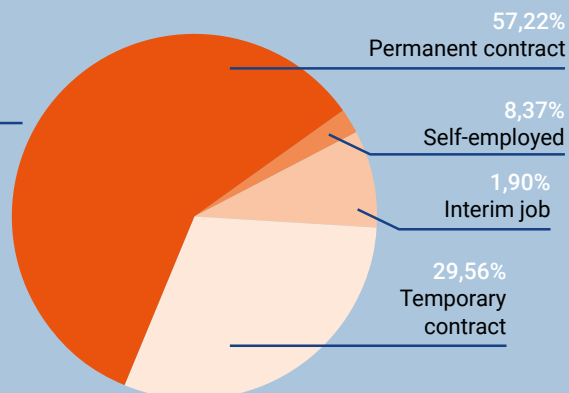

Source: Alumni Survey 2016

INTERNATIONAL STUDENTS



140 NATIONALITIES

4,038 INTERNATIONAL STUDENTS

EEA countries: 1,830 45.3%

NON-EEA countries: 2,208 54.7%



24.5%

INTERNATIONAL STUDENTS IN STUDY PROGRAMMES

Bachelors: 644	15.1%
Masters: 1,320	30.9%
Advanced Masters: 131	3.1%
PhD: 830	19.5%
Other: 1,338	31.4%

* EEA: European Economic Area

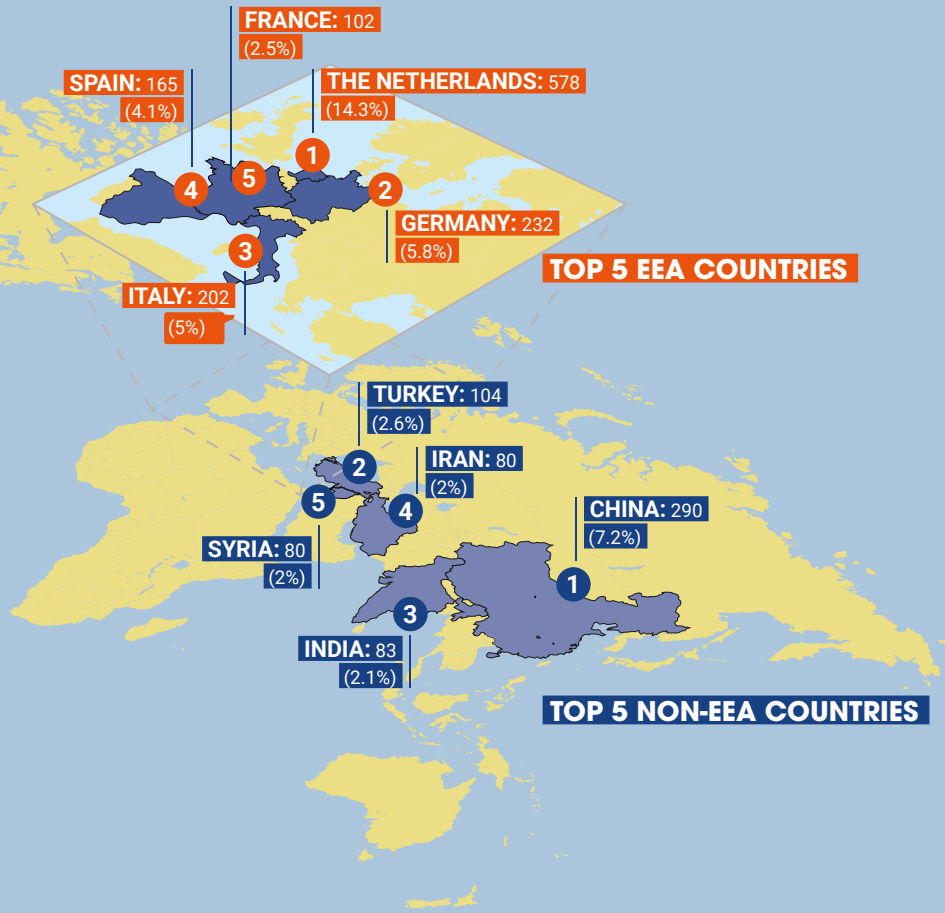

EXCHANGE STUDENTS



2018 - 2019 INCOMING STUDENTS

250 students 2.04 % growth

27 countries

19 EEA - 8 NON-EEA countries



TOP 5 INCOMING COUNTRIES

1	SPAIN	47
2	ITALY	36
3	GERMANY	18
4	CHINA	17
5	FRANCE	16

2018 - 2019 OUTGOING STUDENTS

275 students 0.73 % growth

27 countries

20 EEA - 7 NON-EEA countries

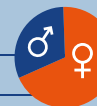

31%

69%

TOP 5 OUTGOING COUNTRIES

1	SPAIN	41
2	GERMANY	21
3	FRANCE	19
4	THE NETHERLANDS	17
5	ITALY	16

EXCHANGE VUB-ULB

Erasmus Belgica

15 incoming students



40%

60%

7 outgoing students



43%

57%

★ EEA: European Economic Area

INCLUSIVE UNIVERSITY

The ALEF Project Arabic Language Classes Project Culture starts with your own identity

VUB started a project on Arabic language courses for 6-15 year old children in Brussels. It is the first Arabic language course in Belgium with academic supervision. The curriculum is checked by specialists and PhD experts in Arabic language. Each lesson contains extra learning activities next to the regular teaching, such as games, Arabic songs etc. Students receive a certificate of attendance by VUB. The children are taught by highly educated refugee teachers who fled their homeland due to war. When people get opportunities, we strengthen society. The more languages we speak, the better we understand one another.



The ALEF project will be expanding to include a Minor in Arabic Language and Culture for the whole VUB student body.

More information on the project website, alef.vub.be

For Scholars Academic Freedom Worldwide

VUB participates in the Scholars at Risk Network. Scholars at Risk works to protect threatened scholars and promote academic freedom around the world.

SCHOLARS AT RISK
NETWORK

For Students Student Refugee Programme and InCAMPUS

The VUB launched its Student Refugee Programme in 2015-2016. The intake of refugee students has increased since then, with a majority coming from Syria, Palestine, Iraq and Afghanistan. In 2018, the VUB added a specific track to the student refugee programme, called InCAMPUS for those refugees who need more help in terms of language, study guidance and psychological support.

InCAMPUS



VUB STUDENT REFUGEE PROGRAMME

Syria	28
Iraq	15
Palestine	8
Afghanistan	5
Somalia	5
Jamaica	1
Kosovo	1
Myanmar	1
Iran	1
Venezuela	1

PER FACULTY

Social Sciences & Solvay Business School	29
Engineering	12
Medicine & Pharmacy	8
Arts & Philosophy	10
Science & Bio-Engineering Sciences	7

STUDY PROGRAMME:

Bachelors	21
Masters	45



66 Refugee students

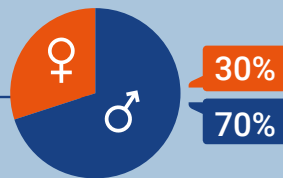

INCAMPUS STUDENTS PREPARATORY PROJECT

• 22 students

• origin

Syria	16
Iraq	2
Palestine	3
Aghanistan	1

• Faculty

Engineering	3
Sciences & Bio-Engineering Sciences	2
Social Sciences & Solvay Business School	8
Medicine & Pharmacy	5
Law & Criminology	2
Arts & Philosophy	2

• Study Programme

Bachelors	10
Masters	12

• Language

10 English-taught
12 Dutch-taught



MORE THAN EDUCATION

VUB education: excellent student/staff ratio:

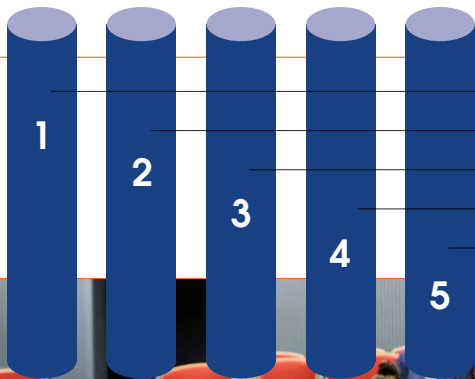

5 Pillars – students

- 1 Turned into reasonable steadfast individuals
- 2 Committed to a sustainable humanist society
- 3 Turned into world citizens
- 4 Develop independent & inquiring attitudes
- 5 Prepared for their professional lives

8 Faculties

- Economic and Social Sciences and Solvay Business School
- Law and Criminology
- Psychology and Educational Sciences
- Arts and Philosophy
- Sciences and Bio-engineering Sciences
- Medicine and Pharmacy
- Engineering
- Physical Education and Physiotherapy

Students appreciate education at VUB

EDUCATION SURVEY 2017-2018

80% of participants are 'rather-very satisfied'



very good: 14%



good: 40%



mediocre: 26%



poor: 7%



unsatisfied: 2%



very unsatisfied: 1%

neutral: 9%



- Students participate in Rector elections
- 10% students represented in all decision-making

54 fully English-taught programmes

- 2 English-taught Bachelors
- 37 English-taught Master & Advanced Master Programmes
- 12 English-taught Postgraduate Certificate programmes
- 3 Multidisciplinary Doctoral Schools

Fields of English-taught programmes

Bachelor in

- Social Sciences (interdisciplinary: Political Sciences, Sociology, Communication Studies)
- Business Economics

Master degree & Advanced Master

- Humanities: Business, Communication, Law, Politics & Economics, Education, Linguistics, European Studies
- Engineering & Exact Sciences
- Life Sciences, Biology

PhD degree

- Offered in more than 30 disciplines

Postgraduates Certificate

- Medicine
- Art, Business
- Economic Diplomacy
- Political & Social Sciences
- Engineering



TOP RESEARCH @VUB

VUB is #48 in top 100 most innovative European Universities



9

RESEARCH CLUSTERS



city dynamics

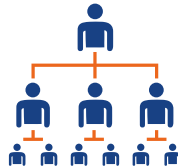

societal challenges



brain & behaviour



the circle of life



smart engineering

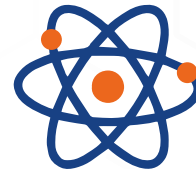

smallest particles



fighting diseases



environmental issues



big data

ALMOST 110 MILLION FOR RESEARCH



ERC GRANTS 2017-2018

11 ongoing

- 6 Starting
- 1 Consolidator
- 2 Advanced
- 2 VIB-VUB - Consolidator master's thesis

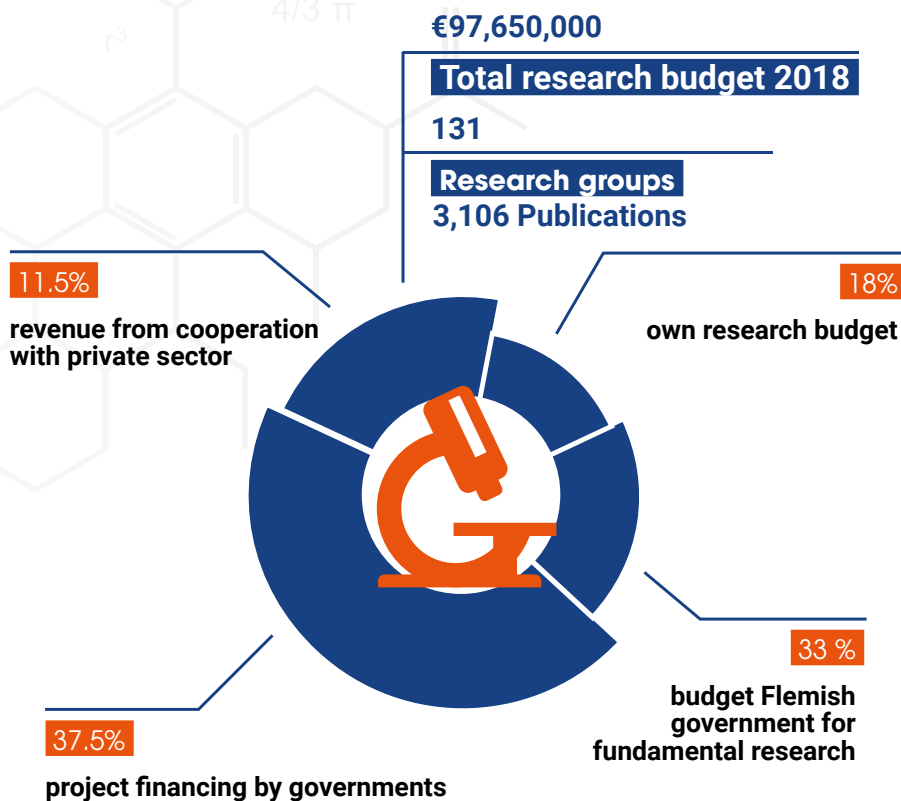

UNIVERSITY HOSPITAL (UZ BRUSSEL) RESEARCH

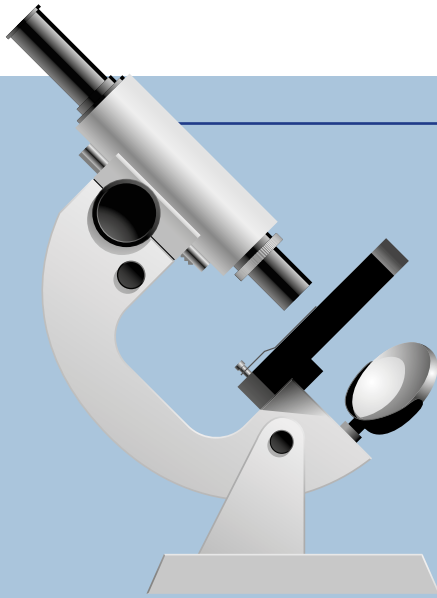

10 RESEARCH CLUSTERS

- Development, Ageing and Pathology
- Diabetes, Transplantation & Pathology
- Liver & Cell Biology and Toxicology
- Medical Imaging & Physical Sciences
- Neurosciences
- Oncology Research Centre
- Pharmaceutical Research and Data Technology
- Public Health
- Reproduction, Genetics and Regenerative Medicine
- Research Center for Cardiovascular Diseases

523
Clinical Research Files
@Medical Ethics
Commission

+20% in 2018



1,006 publications
in 2018 UZ Brussel
& Faculty Medicine
& Pharmacy



CANCER

- 1st Radixact treatment worldwide & Innovative immunotherapy
- Precision reads tumor DNA
- Shorter/personalized breast cancer treatment

DIABETES

- Sophisticated tools & integrated care of type 1 diabetes
- mHealth - telemonitoring - and Robocure for children

LYMPH EDEMA

Lymph clinic treats forgotten patients after cancer treatment

BLOOD TRANSFUSION

IT team UZ Brussel develops App to scan blood for transfusion

HEART

- Innovative CT-scan can prevent invasive surgery in cathlab
- 44 wireless pacemakers paid by UZ Brussel

FERTILITY

Oncofertility assures fertility of cancer patient after treatment

SURGERY

TECHNIQUES

- Hololens brings augmented reality in the surgery room
- 1st Belgian hospital to use computer assisted technology for back surgery



NETWORK

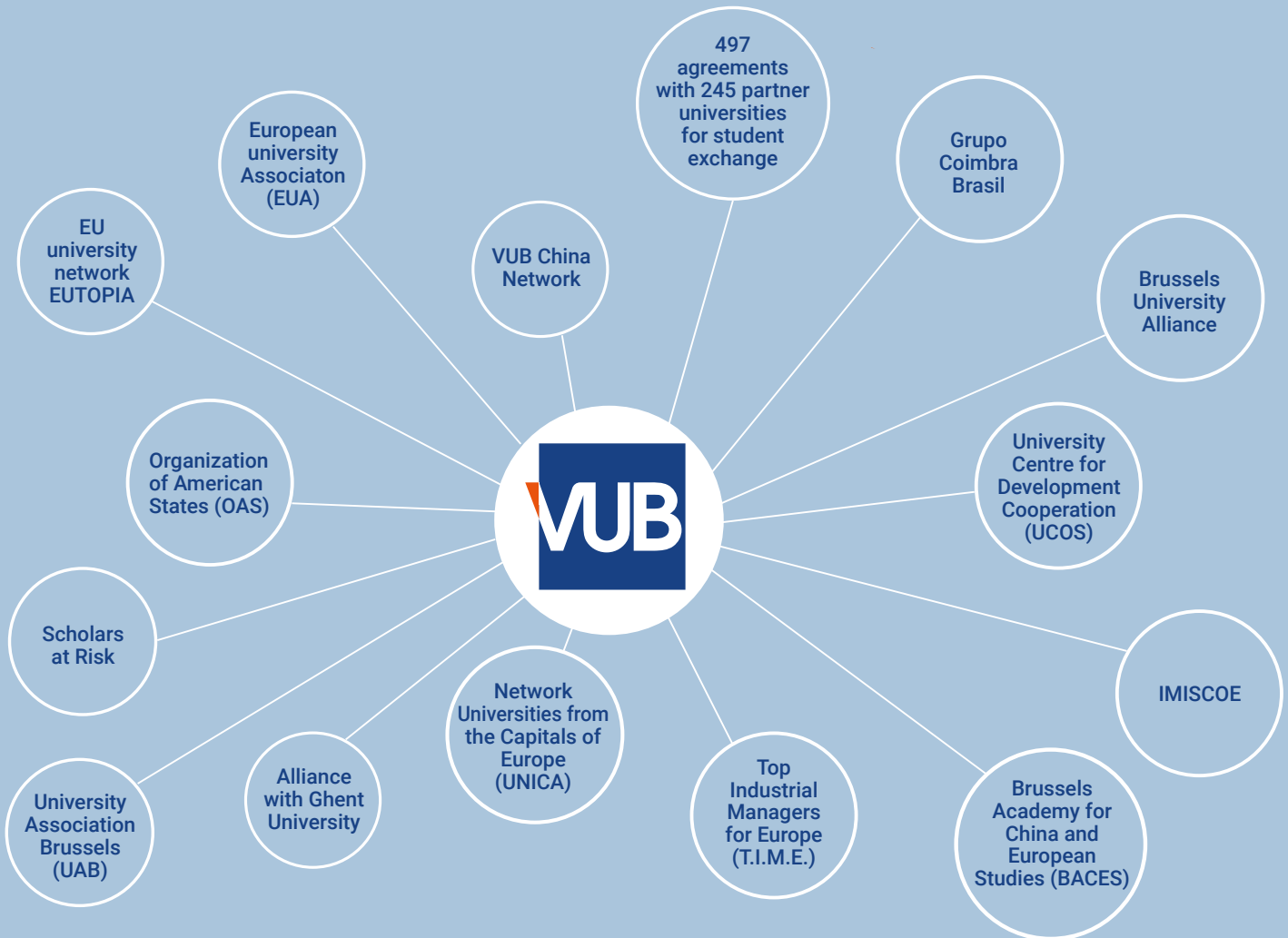

VUB FOUNDATION

What you give to the VUB, you get back.

VUB receives financial support from the government but it is not sufficient to optimise the work on core tasks or initiate innovative projects. This is why we set up the VUB Foundation. Alternatively, they can establish a registered fund in connection to such a project. The VUB Foundation can help you in this regard. If you have a certain faculty, specific research group or project in mind you would like to support, then we will help you and in consultation with your

legal advisor can assist you in making the best choices in terms of your financial assets.

For more information, please contact us at any time for a non-binding conversation with

Isabelle Marneffe,
Director of the VUB Foundation.

Email: isabelle.marneffe@vub.be or call +32 2 629 15 42



With weKONEKT.brussels,
**VUB and ULB launched a new concept:
our students pouring into Brussels for
their classes.**





#WeAreVUB

VUB means education, research and social commitment. Its values are based on radical humanism, which translates into the principles of freedom, equality, and solidarity.

Freedom for us means free research: the rejection of every purely authoritative argument and the guarantee of freedom of research.

Equality means fairness and recognition of diversity.

Societal commitment represents our commitment to the major societal challenges and our concern for a sustainable society. Have respect for our fellow human beings and the world. This is VUB.

As a university we continuously strive towards proactively improving and modernising our education offering. We optimise and innovate our research, ensuring it is international, interdisciplinary and carried out within an environment of excellence. We aim to be the point of reference for work and study, by providing continued support and training to our students and staff. We want to further our connectedness to the world and to the city we are based in, to forge national and international partnerships, and encourage social entrepreneurship, develop projects with the city of Brussels, with our alumni in Belgium but also on the international level.

We must continue to improve and further develop our relationships abroad through development cooperation, within our networks, and

with our association partners to ensure our work, both in education and research, is internationally well-founded and improves our societal commitment.

VUB sits in the heart of Brussels, which itself is the capital of Belgium and Europe. One third of its population is of foreign origin, giving the city an amazing variety of cultures and nationalities. It houses the headquarters of many organisations and multinationals, the EU institutions, NATO, and a wide array of NGOs. In terms of quality of living, Brussels ranks 28th in the Mercer poll of 2019. Belgium is ranked 21th in the World Economic Forum's Global Competitiveness's Index 2018. In terms of higher education and training, it ranks 11th in the world. It is by its very nature a truly international city, where students from across the world can feel at home, learn from each other, and explore new worlds.

VUB, like the city it calls home, is an international university, with increasing international students and staff on its campuses. As a university, it embraces all that the city stands for: welcoming, open, innovative, diverse and interesting.

Welcome to VUB. Welcome to Brussels!

Caroline Pauwels, rector VUB

Responsible publisher

Prof. Dr. Caroline Pauwels
Rector Vrije Universiteit Brussel

Realisation

Vrije Universiteit Brussel
Dienst Marketing & Communicatie
Pleinlaan 9 | 1050 Brussel | Belgium
+32 (0) 629 12 98 | marcom@vub.be

Illustrations

Greet De Gendt, Deborah Puylaert, Frankie Verdickt,
Marcom, IRMO, Universiteitsarchief VUB

Layout

Gekko

Vrije Universiteit Brussel
Pleinlaan 2 | 1050 Brussel | Belgium
+32 (0) 629 21 11
www.vub.be/en | info@vub.be

International Relations Office
Visitors: Pleinlaan 5 | 1050 Brussel | Belgium
+ 32 (0) 614 81 01
international.relations@vub.be

facebook.com/VUBrussel
facebook.com/VUBInternationalRelations
twitter.com/vubrussel | instagram.com/vubrussel
vubtoday.be





vub.be/en

